

Алматы (7273)495-231
Ангарск (3955)60-70-56
Архангельск (8182)63-90-72
Астрахань (8512)99-46-04
Барнаул (3852)73-04-60
Белгород (4722)40-23-64
Благовещенск (4162)22-76-07
Брянск (4832)59-03-52
Владивосток (423)249-28-31
Владикавказ (8672)28-90-48
Владимир (4922)49-43-18
Волгоград (844)278-03-48
Вологда (8172)26-41-59
Воронеж (473)204-51-73
Екатеринбург (343)384-55-89
Иваново (4932)77-34-06
Ижевск (3412)26-03-58
Иркутск (395)279-98-46
Казань (843)206-01-48

Калининград (4012)72-03-81
Калуга (4842)92-23-67
Кемерово (3842)65-04-62
Киров (8332)68-02-04
Коломна (4966)23-41-49
Кострома (4942)77-07-48
Краснодар (861)203-40-90
Красноярск (391)204-63-61
Курган (3522)50-90-47
Курск (4712)77-13-04
Липецк (4742)52-20-81
Магнитогорск (3519)55-03-13
Москва (495)268-04-70
Мурманск (8152)59-64-93
Набережные Челны (8552)20-53-41
Нижний Новгород (831)429-08-12
Новокузнецк (3843)20-46-81
Новосибирск (383)227-86-73
Ноябрьск(3496)41-32-12

Омск (3812)21-46-40
Орел (4862)44-53-42
Оренбург (3532)37-68-04
Пенза (8412)22-31-16
Пермь (342)205-81-47
Петрозаводск (8142)55-98-37
Псков (8112)59-10-37
Ростов-на-Дону (863)308-18-15
Рязань (4912)46-61-64
Самара (846)206-03-16
Санкт-Петербург (812)309-46-40
Саранск (8342)22-96-24
Саратов (845)249-38-78
Севастополь (8692)22-31-93
Симферополь (3652)67-13-56
Смоленск (4812)29-41-54
Сочи (862)225-72-31
Ставрополь (8652)20-65-13
Сургут (3462)77-98-35

Сыктывкар (8212)25-95-17
Тамбов (4752)50-40-97
Тверь (4822)63-31-35
Тольятти (8482)63-91-07
Томск (3822)98-41-53
Тула (4872)33-79-87
Тюмень (3452)66-21-18
Улан-Удэ (3012)59-97-51
Ульяновск (8422)24-23-59
Уфа (347)229-48-12
Хабаровск (4212)92-98-04
Чебоксары (8352)28-53-07
Челябинск (351)202-03-61
Череповец (8202)49-02-64
Чита (3022)38-34-83
Якутск (4112)23-90-97
Ярославль (4852)69-52-93

Россия +7(495)268-04-70

Казахстан +7(7172)727-132

Киргизия +996(312)96-26-47

<https://opti.nt-rt.ru> || opti@nt-rt.ru

УЛЬТРАЗВУКОВЫЕ РАСХОДОМЕРЫ

UFM 800





UFM 800 W, C and UFM 800 W Hot Tapping

Ultrasonic flowmeter for water and wastewater

... with weld-in sensors for metal pipelines
... with built-on or built-in sensors for open channels

Efficient flow measurement and volume counting of all types of water and wastewater in closed pipelines or in open channels and raceways.

Advantages

- No constriction of the pipe cross-section
- No additional pressure drop
- Electrical conductivity, pressure, density, etc. have no effect on measurements
- Easy to install from the outside or the inside
- No maintenance requirement
- Low power consumption
- Low operating costs

UFC 030 F signal converter

- Large local LC display and push buttons
- Digital signal processing
- Easy to operate
- Current, pulse, frequency and status outputs
- Low power consumption



UFM 800 W

Ultrasonic flowmeters with UFS 800 W sensors for measuring the volumetric flowrate in metal pipelines. The sensors are welded to the outside of the pipelines.



UFM 800 C

Ultrasonic flowmeter with UFS 800 C sensors for measuring flow velocity in open channels. The sensors can be installed or mounted from the inside or outside of the channel.

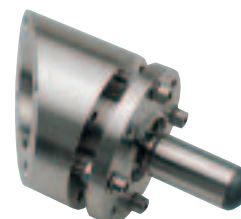

UFM 800 W Hot Tapping

Hot Tapping technology allows retrofitting on to existing pipelines without **interrupting the process.**

UFM 800 W Hot Tapping ultrasonic flowmeters are designed for volumetric flow measurement and counting in closed pipelines with inside diameters of DN 500 – DN 5000.

UFM 800 W Hot Tapping flowmeters are suitable for all sectors of the water and wastewater industry. The UFM 800 W is the device of choice in many other industrial sectors.

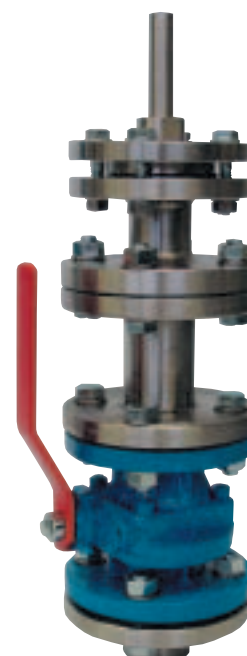

Systems

UFM 800 W
UFM 800 W Hot Tapping
 for measuring process liquids
 in metal pipelines
 DN 500-5000 / 20"-200"



UFM 800 C

for measuring process liquids
 in open channels
 Width: 400-8000 mm

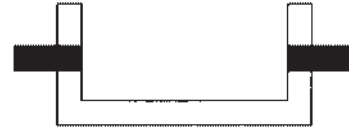

Versions

Sensors

Single-beam measurement
 Double-beam measurement
 Triple-beam measurement
Signal converter

2 x UFS 800 W
 4 x UFS 800 W (option)
 6 x UFS 800 W (option)
 UFC 030 F

2 x UFS 800 C
 -
 -
 UFC 030 F

Application/Measurement

- Actual volume flowrate
- Actual volume total
- Flow direction
- Transit time measurement

- Actual volume flowrate
- Flow direction

Measuring accuracies

Error: single-beam
 Error: double-beam
 Error: triple-beam
 Repeatability

typical values, dependent upon application
 <± 1% of measured value
 <± 0.7% of measured value
 <± 0.5% of measured value
 ± 0.2% of measured value

typical values, dependent upon application
 ± 5% of measured value
 -
 -
 ± 0.2% of measured value

Flow velocity

0.5 - 20 m/s; 1.5 - 60 ft/s

0.5 - 20 m/s; 1.5 - 60 ft/s

Technical data

Sensors

**UFS 800 W
UFS 800 W Hot Tapping**



UFS 800 C

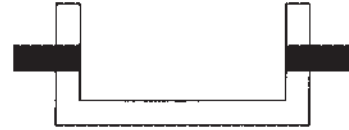

Versions

Single-beam measurement
Double-beam measurement
Triple-beam measurement

2 x UFS 800 W
4 x UFS 800 W (option)
6 x UFS 800 W (option)
replaceable at operating pressure

2 x UFS 800 C
-
-

Application data

Mounting location

installation in metal pipelines
sensors welded outside pipelines

Installation in open channels,
Mounted from the outside or the inside
by technicians with laser alignment set

Sensor alignment

DN ≤ 1000 / ≤ 40"
acoustic alignment (water only)
DN > 1000 / > 40"
by technicians using laser alignment set

Operating data

Process temperature
Pressure
Ambient temperature
Storage temperature (electronics)
(electronics)

- 50 to +180°C / - 58 to +356°F
max. 40 bar / max. 580 psig
- 25 to +60°C / - 13 to +140°F
- 40 to +65°C / - 40 to +149°F

- 25 to +120°C / - 13 to +248°F
max. 10 bar / max. 150 psig
- 25 to +60°C / - 13 to +140°F
- 40 to +65°C / - 40 to +149°F

Protection category

(IEC529/EN 60529)
Standard
Optional

IP 65 equivalent to NEMA 4 and 4X
IP 67, IP 68 equivalent to NEMA 6

IP 65 equivalent to NEMA 4 and 4C
IP 67, IP 68 equivalent to NEMA 6

Material

Sensor
Sensor mount

stainless steel 1.4404 equivalent to SS 316 L
stainless steel 1.4301 equivalent to SS 304
others on request

stainless steel 1.4301 or SS 304, Pyrex and Viton
stainless steel 1.4301 or SS 304 and Viton
others on request

Ex-approval

ATEX

Dimensions and weights

UFC 030F signal converters

Weight: approx. 4.2 kg (9.3 lb)

Dimensions in mm and (inch)

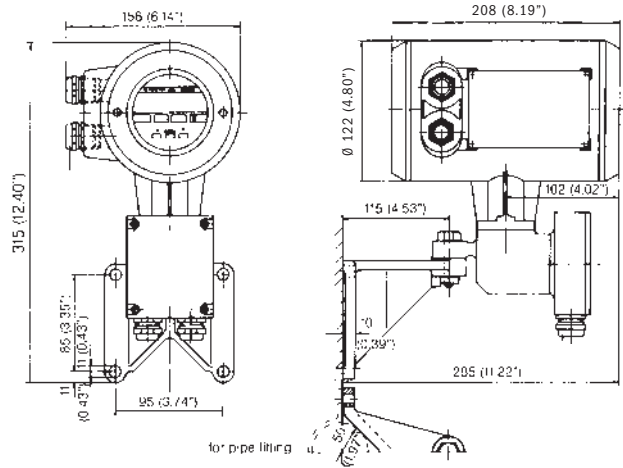

UFS 800 W sensors

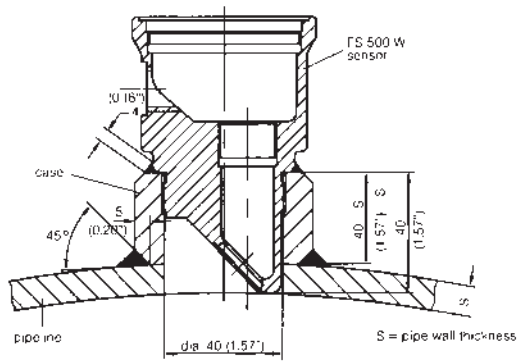

UFS 800 C sensors

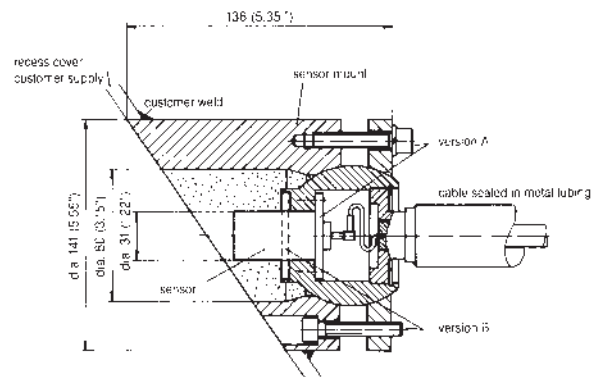

UFC 030 F Signal converters

Versions

Standard UFC 030 F with HART® communication protocol
 Option UFC 030 F with PROFIBUS-PA communication protocol

Full-scale range

Flow velocity 0.5 - 20 m/s or 1.5 - 60 ft/s
 Units for volume m³, US Gallons and others

Measurements available

- Continuous measurement of momentary volume flow rate and actual volume total
- Flow direction (forward or reverse)
- Velocity of Sound (VOS)
- Signal strength
- Self diagnostics

Bidirectional measurement

Direction identified via status, pulse or current outputs

Low flow cut-off

Cut-off active value 1-19% } set in increments of 1%
 Cut-off de-active value 2-20% }

Time constant

0.025 - 99 seconds, set in increments of 0.01, 0.1 or 1.0 seconds

Galvanic isolation

All inputs and outputs are galvanically isolated from the power supply, but not from each other

Power supply

AC ● 100 - 240 V / 48 - 63 Hz / +10% / -15%
 DC/AC (low voltage) ● DC: 24 V / 18 - 35 V
 ● AC: 24 V / 48 - 63 Hz / -10% / +15%

Power consumption

- AC: approx. 10 VA
- DC: approx. 10 W

Current output

Function

- Continuous measurement of actual volume flow rate
- Flow direction indication (forwards and reverse)
- Velocity of Sound (VOS)
- Transducer signal amplification

Settings

for Q = 0%; 0 - 16 mA } set in increments of 1mA (limit 20 - 22 mA)
 for Q=100%; 4 - 20 mA }

Connection

Active mode: using internal power supply 24 V DC
 Current sink, load ≤ 680 ohm
 Passive mode: external voltage ≤ 18 ... 24 V DC, load ≤ 680 ohm

Pulse / Frequency / Status output

Function

- Pulse output: pulse per volumetric unit (m³, barrels, liters, US gallons or user defined volume unit per hour, minute, second or user defined time unit)
 - Actual volume
- Frequency output
 - Continuous measurement of actual volume flow rate
 - Velocity Of Sound (VOS)
 - Transducer signal gain (dB)
- Status output
 - Diagnostics alarm path errors, totalizer overrun, all errors, analog input
 - Flow direction indication (forwards and reverse)
 - Alarm trip point (high and low) based on actual volume flow rate

Settings

- Pulse output: Pulse/unit (max. 2000 Hz) (example 1000 pulses/barrel) pulse duty cycle 25, 50, 100, 200, or 500 ms for frequency < 10 Hz
- Frequency output: 0 to 2 000 Hz (example Q_{0%} - 0 Hz, Q_{100%} - 1000 Hz) at 100% of scale value, fmax - 2 kHz
- Status output: On or Off
- Voltage output = Uout: Low: Uout < 5 V (off)
High: Uout > 15 V (on)
Max. Uout = 24 VDC

Connection

- Pulse, frequency and status output:
 - Active mode connection to electronic counters using internal power supply 24 V DC / I ≤ 50 mA
 - Passive mode connection to electronic (EC) or electromechanical counters (EMC) external voltage, ≤ 19 - 32 VDC / I ≤ 150 mA

Control input

- Function**
 - Reset totalizer
 - Acknowledge errors
 - Force outputs to zero
- Setting**
 - On or Off
- Connection**
 - Input voltage (Uin)
 - Low: Uin < 5 V (off)
 - High: Uin > 15 V (on)
 - Max.: Uin-max = 32 V

Local display

3-field backlit LCD
 1st line 8 character 7 segment numeral and sign display and symbols for key acknowledgement
 2nd line 10 character, 14 segment text display
 3rd line 5 markers to identify display in measuring mode

- Function**
 - Actual volume flow rate in m³, barrels, liters, US gallons or user defined volume unit per hour, minute, second, or user defined time unit
 - Actual volume total in m³, barrels, liters, US gallons or user defined volume unit (positive, negative, and sum totals), minimum 1 year overflow time
 - Velocity of sound in m/s or ft/s
 - Errors (flashing display and error code)
 - Signal strength (in dB)

Language English, German or French

Housing Die-cast aluminium (exterior polyurethane coated)

Signal cable

- Diameter: 11 mm (0.43 inch)
- Length: Standard: 5 m (15 ft)
- Optional: 10 m (30 ft), 15 m (45 ft), 20 m (65 ft), 25 m (80 ft), 30 m (100 ft), > 30 m (> 100 ft) on request

UFM 800 W for pipelines

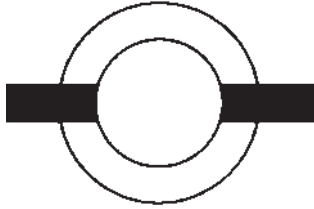

**UFS 800 W
Mounting location and installation**

- Position the UFM 800 W in the pipeline such that the measuring tube is completely filled with the process liquid at all times, even at “zero” flow velocity.
Make sure that the measuring beam is approximately horizontal.
- Installation and alignment of UFS 800 W ultrasonic sensors can be completed by technicians.
- Install UFC 500 F signal converter in the vicinity of the measuring point (UFS 800 W sensors).
- **Gas content**
The gas content in the process liquid must not exceed a maximum of 0.2% by volume at flowing conditions.

Please note:

Even in liquids that are virtually gas-free, large quantities of gas may form if the liquid is allowed to expand before reaching the measuring point, e.g. downstream of partially closed valves or small pump outlets.

● Inlet and outlet runs	<u>Single-beam</u>	<u>Double-beam</u>
Inlet	20 x DN	10 x DN
Outlet	5 x DN	10 x DN
(DN = meter size, pipe diameter)		

UFM 800 C for open channels

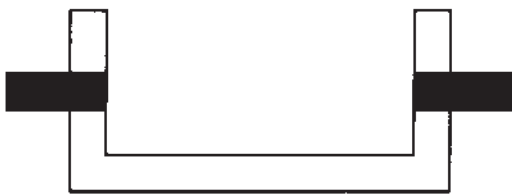

**UFS 800 C
Mounting location and installation,**

- Inlet run: 10 x B
Outlet run: 5 x B
(B = width of channel)
- Sensors can be installed either from the inside or the outside of the channel.
- Sensors aligned by technicians are precisely set using laser alignment.

Electrical connection, UFC 030 F

- **Power supply, power consumption and load rating** of outputs: see "Technical data" (page 6+7)
- **Current and pulse outputs (I + P) are galvanically isolated** from all input and output circuits, when used in passive mode.
- Use the supplied signal cables (coaxial), length 5 m /16 ft (or optionally longer) for the electrical connection between sensors and signal converter.
- Ambient temperature must be from -25 to +60°C (-13 to +140°F), therefore do not cover signal converter with heat-insulating materials, and do not expose to strong sunlight or other heat sources.
- Avoid intensive vibration.



Standard connection



Profibus connection



- 10 Ground connection, not for protective earthing
- L / 1L~ Live power supply
- N / 0L~ Neutral power supply
- PE Protective earth connection
- FE Functional earth connection
- ⊥ Common ground
- A1 Analog input 1, for temperature measurement
- A2 Analog input 2, for pressure measurement
- P Pulse, frequency or status output
- I/C Combined Current output (I) and Digital/control input (C)
Current output (I) incl. HART communication
- V+ DC power supply from converter for active wiring of inputs and outputs
- D Communication connection+
- D⊥ Communication connection -
- P Combined current output (I), digital/control (C) and pulse output (P). See individual I/C terminal and P terminal functions

Connection diagram examples

Current output

Active

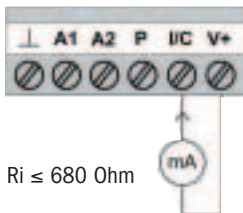

Passive

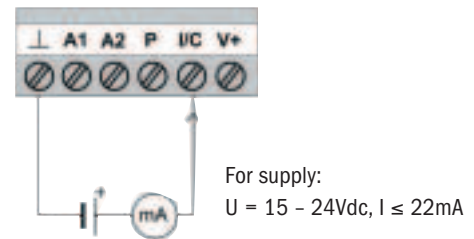

Pulse output

Active

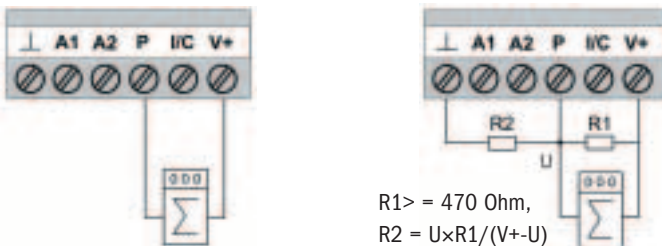

Passive

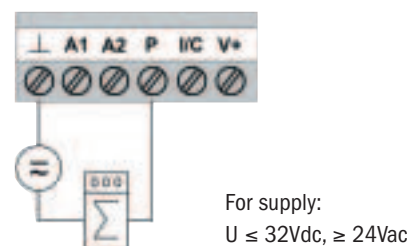

Digital / Control input

Active

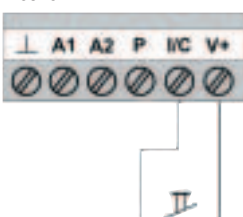

Passive

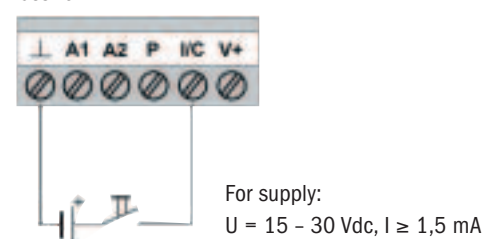

Installing a UFS 800 W sensor with Hot Tapping

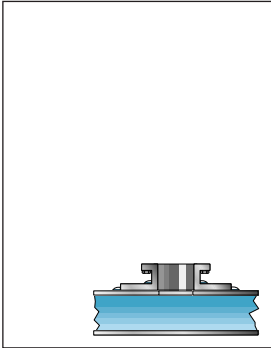

Weld socket to the pipeline

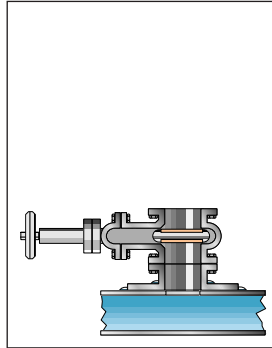

Fit the valve and close it

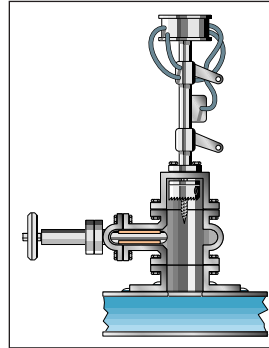

Mount the hot tapping drill, open the valve

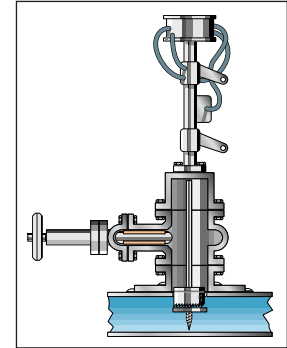

Cut a hole in the pipe wall

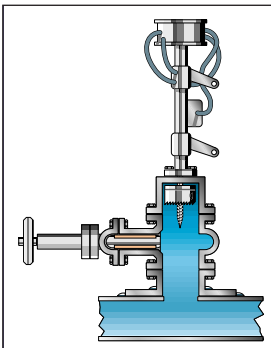

Withdraw cutter incl. the cut-out

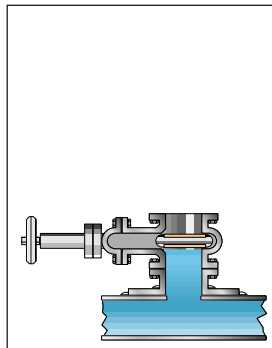

Close valve and remove the hot tapping drill

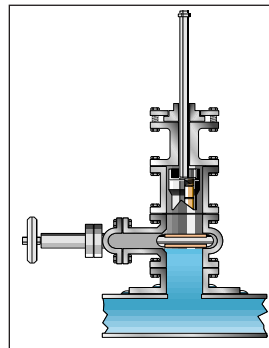

Mount carrier with sensor on the valve

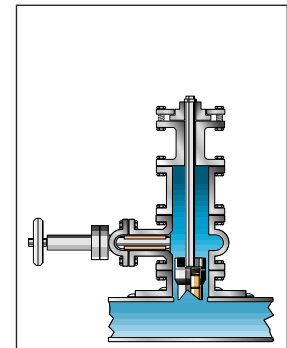

Open valve, position and align ultrasonic sensor

Алматы (7273)495-231
 Ангарск (3955)60-70-56
 Архангельск (8182)63-90-72
 Астрахань (8512)99-46-04
 Барнаул (3852)73-04-60
 Белгород (4722)40-23-64
 Благовещенск (4162)22-76-07
 Брянск (4832)59-03-52
 Владивосток (423)249-28-31
 Владикавказ (8672)28-90-48
 Владимир (4922)49-43-18
 Волгоград (844)278-03-48
 Вологда (8172)26-41-59
 Воронеж (473)204-51-73
 Екатеринбург (343)384-55-89
 Иваново (4932)77-34-06
 Ижевск (3412)26-03-58
 Иркутск (395)279-98-46
 Казань (843)206-01-48

Калининград (4012)72-03-81
 Калуга (4842)92-23-67
 Кемерово (3842)65-04-62
 Киров (8332)68-02-04
 Коломна (4966)23-41-49
 Кострома (4942)77-07-48
 Краснодар (861)203-40-90
 Красноярск (391)204-63-61
 Курган (3522)50-90-47
 Курск (4712)77-13-04
 Липецк (4742)52-20-81
 Магнитогорск (3519)55-03-13
 Москва (495)268-04-70
 Мурманск (8152)59-64-93
 Набережные Челны (8552)20-53-41
 Нижний Новгород (831)429-08-12
 Новокузнецк (3843)20-46-81
 Новосибирск (383)227-86-73
 Ноябрьск (3496)41-32-12

Омск (3812)21-46-40
 Орел (4862)44-53-42
 Оренбург (3532)37-68-04
 Пенза (8412)22-31-16
 Пермь (342)205-81-47
 Петрозаводск (8142)55-98-37
 Псков (8112)59-10-37
 Ростов-на-Дону (863)308-18-15
 Рязань (4912)46-61-64
 Самара (846)206-03-16
 Санкт-Петербург (812)309-46-40
 Саранск (8342)22-96-24
 Саратов (845)249-38-78
 Севастополь (8692)22-31-93
 Симферополь (3652)67-13-56
 Смоленск (4812)29-41-54
 Сочи (862)225-72-31
 Ставрополь (8652)20-65-13
 Сургут (3462)77-98-35

Сыктывкар (8212)25-95-17
 Тамбов (4752)50-40-97
 Тверь (4822)63-31-35
 Тольятти (8482)63-91-07
 Томск (3822)98-41-53
 Тула (4872)33-79-87
 Тюмень (3452)66-21-18
 Улан-Удэ (3012)59-97-51
 Ульяновск (8422)24-23-59
 Уфа (347)229-48-12
 Хабаровск (4212)92-98-04
 Чебоксары (8352)28-53-07
 Челябинск (351)202-03-61
 Череповец (8202)49-02-64
 Чита (3022)38-34-83
 Якутск (4112)23-90-97
 Ярославль (4852)69-52-93