

Алматы (7273)495-231
Ангарск (3955)60-70-56
Архангельск (8182)63-90-72
Астрахань (8512)99-46-04
Барнаул (3852)73-04-60
Белгород (4722)40-23-64
Благовещенск (4162)22-76-07
Брянск (4832)59-03-52
Владивосток (423)249-28-31
Владикавказ (8672)28-90-48
Владимир (4922)49-43-18
Волгоград (844)278-03-48
Вологда (8172)26-41-59
Воронеж (473)204-51-73
Екатеринбург (343)384-55-89
Иваново (4932)77-34-06
Ижевск (3412)26-03-58
Иркутск (395)279-98-46
Казань (843)206-01-48

Калининград (4012)72-03-81
Калуга (4842)92-23-67
Кемерово (3842)65-04-62
Киров (8332)68-02-04
Коломна (4966)23-41-49
Кострома (4942)77-07-48
Краснодар (861)203-40-90
Красноярск (391)204-63-61
Курган (3522)50-90-47
Курск (4712)77-13-04
Липецк (4742)52-20-81
Магнитогорск (3519)55-03-13
Москва (495)268-04-70
Мурманск (8152)59-64-93
Набережные Челны (8552)20-53-41
Нижний Новгород (831)429-08-12
Новокузнецк (3843)20-46-81
Новосибирск (383)227-86-73
Ноябрьск(3496)41-32-12

Омск (3812)21-46-40
Орел (4862)44-53-42
Оренбург (3532)37-68-04
Пенза (8412)22-31-16
Пермь (342)205-81-47
Петрозаводск (8142)55-98-37
Псков (8112)59-10-37
Ростов-на-Дону (863)308-18-15
Рязань (4912)46-61-64
Самара (846)206-03-16
Санкт-Петербург (812)309-46-40
Саранск (8342)22-96-24
Саратов (845)249-38-78
Севастополь (8692)22-31-93
Симферополь (3652)67-13-56
Смоленск (4812)29-41-54
Сочи (862)225-72-31
Ставрополь (8652)20-65-13
Сургут (3462)77-98-35

Сыктывкар (8212)25-95-17
Тамбов (4752)50-40-97
Тверь (4822)63-31-35
Тольятти (8482)63-91-07
Томск (3822)98-41-53
Тула (4872)33-79-87
Тюмень (3452)66-21-18
Улан-Удэ (3012)59-97-51
Ульяновск (8422)24-23-59
Уфа (347)229-48-12
Хабаровск (4212)92-98-04
Чебоксары (8352)28-53-07
Челябинск (351)202-03-61
Череповец (8202)49-02-64
Чита (3022)38-34-83
Якутск (4112)23-90-97
Ярославль (4852)69-52-93

Россия +7(495)268-04-70

Казахстан +7(7172)727-132

Киргизия +996(312)96-26-47

<https://opti.nt-rt.ru> || opti@nt-rt.ru

ДАТЧИКИ pH/ORP

SMARTPAT PH SMARTPAT ORP



SMARTPAT – New level of process analysis

Thanks to the integrated transmitter technology the SMARTPAT sensor significantly **reduces the risk of failure** from sensor to process control system and **eases the handling** of analytical sensors in a revolutionary way.



The **complete circuitry has been miniaturised** and fits into the sensor head. This not only reduces the costs of ownership, eases installation and maintenance, it also allows for **direct usage in explosive areas (zone 0)**.

KROHNE is the only supplier that uses a real open standard – and therefore a **direct connection from sensor to the process control system via the standardised fieldbus**. The SMARTPAT sensors store all data and transfer it bidirectionally and digitally with the 4...20 mA current signal via the HART® protocol to process control and asset management systems, handhelds, PCs and other peripheral devices.

SMARTPAT sensors can be **easily configured and calibrated via PACTware™ (FDT/DTM) or HART® DD**. Due to the offline calibration and regeneration, they feature accurate measurement and an **extended service life**.

For any industrial applications

- Measurement of pH, ORP and conductivity
- Installation in zone 0 (Versions with ATEX, FM, IECEx, NEPSI approval)
- Wide variety of pH membrane glasses, reference systems and diaphragms to suit most process conditions
- Application-related choices of cell constants, conductivity sensor designs and robust materials
- Small footprint plug & play installations ideal for integrators and packaged units

Standardised plug head VarioPin VP2

Miniaturised, integrated transmitter technology

Thread PG 13.5

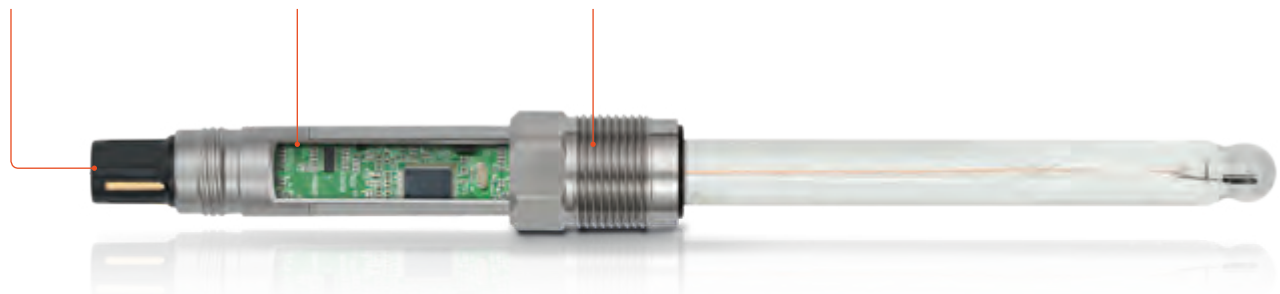

Saves a lot of money, time and effort

SMARTPAT cost advantage due to no external transmitter required

The elimination of the external transmitter reduces the price considerably in comparison with any other competing measuring system.

Cost of investment	SMARTPAT	Analog
Sensor	323 EUR	295 EUR
Cable	200 EUR	200 EUR
Display / transmitter	–	1,000 EUR
Commissioning	60 EUR	180 EUR
Equipment for the offline calibration (non-recurring)	3,500 EUR	–
Cost of investment per 100 measuring loops	61,800 EUR	167,500 EUR

105,700 EUR

SMARTPAT cost advantage for 100 measurement loops due to no external transmitter required

SMARTPAT cost advantage due to regeneration and offline calibration

Offline calibration reduces time and effort significantly. At the same time, it increases productivity and efficiency. A big plus is that the service life of the sensors increases by up to a factor of 3, with an average factor of 2.

Operational costs	SMARTPAT	Analog
Calibration time requirement	30 min	45 min
Calibration per month	45 EUR	90 EUR
Maintenance per month	60 EUR	60 EUR
Cost of operation per 100 measuring loops per year	92,300 EUR	143,500 EUR

51,200 EUR

SMARTPAT cost advantage due to regeneration and offline calibration per year

The calibration and maintenance costs consist of expenditure of time and labour costs for specialist and non-specialist, depending on the task. The above example is based on a water or wastewater application with 1 calibration per month and one sensor exchange per year each. Additional savings might be achieved due to reduced maintenance time per sensor.

Please contact us to get a more precise overview of the savings potential based on your parameters.

Makes changeover easy



VarioPin VP2

Simple retrofitting

Thanks to its **standardised connector use**, SMARTPAT sensors are compatible with a wide range of the existing mounting assemblies and can be installed in keeping with operational safety. Plug heads are available in **nickel-plated brass or PEEK** depending on the sensor type and with **VarioPin VP2**.

Easy to install

SMARTPAT sensors function as a **2-wire loop powered system**. They can be used both in **point-to-point** operation and for **multi-drop** installations.



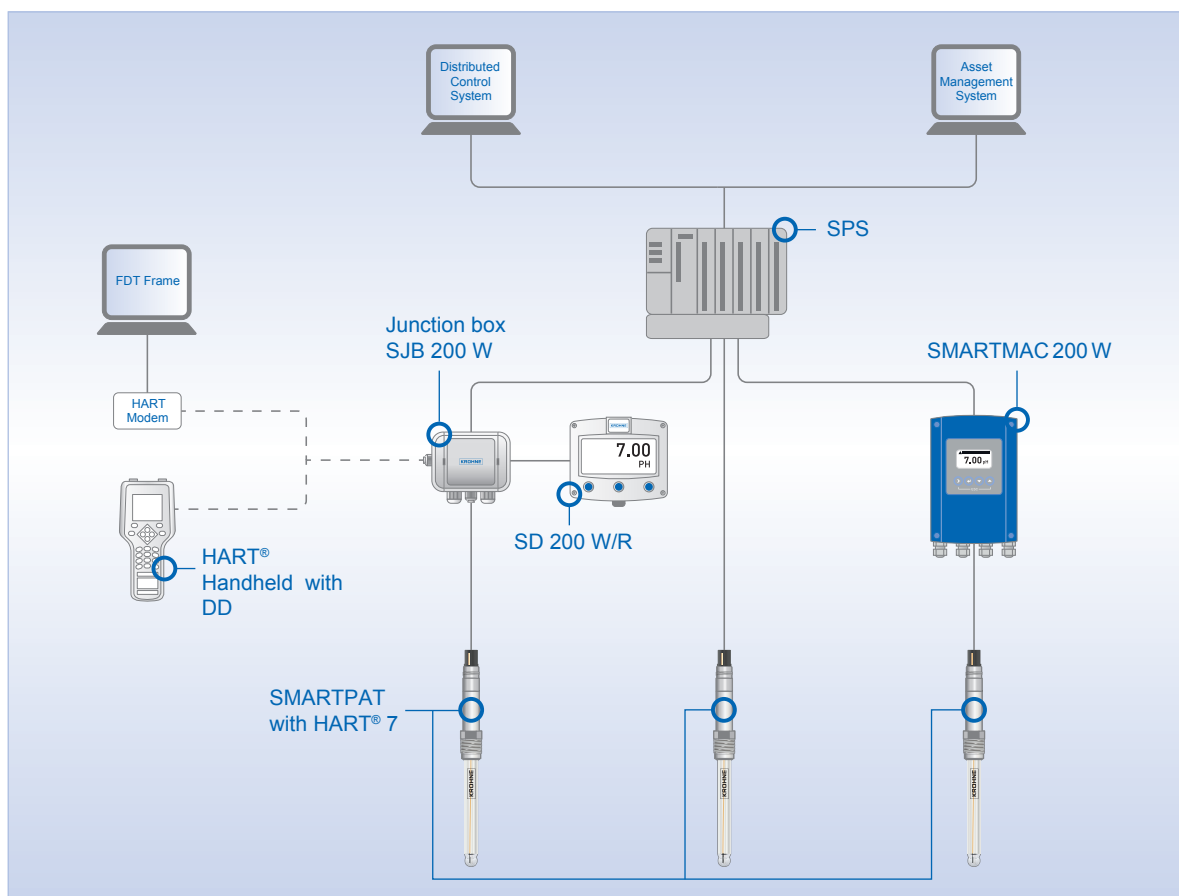

Easy to operate

SMARTPAT sensors are **HART® 7-certified** by the HART Communication Foundation (HCF) and can be easily operated with **any commercially available HART® handheld** device.

Sensor configuration is possible using a HART® handheld device or via **freely available PACTware™ FDT/DTM** on other conventional asset management and process control systems.

Knows best what should be done and when

Stores more, does more

SMARTPAT sensors **store all relevant data**, which can be **accessed via the HART® protocol**, including important information such as **configuration data and maintenance frequency**.

Thinks far ahead

The data output from the SMARTPAT series meets the standards of **NAMUR NE 107 and VDI / VDE 2650**. SMARTPAT analytical sensors recognise and **report the correct time period for maintenance**. This prevents calibration from being performed too early. Your benefit: more functionality with less labour and lower sensor abrasion.



Provides a consistent operating concept

Effortless user access

The **standardised HART® 7 protocol** of the SMARTPAT series allows the **same software to be used**.

The result: a consistent operating structure in offline calibration and on the handheld device as well as in the asset management and process control systems. In this way, **all users always have access** to the same measuring values and data, which can be used in a flexible manner and administered regardless of manufacturer.

The SMARTPAT DTMs run smoothly on conventional or stand alone systems, e.g PACTware™ asset management and process control systems.



Very easy to calibrate offline

SMARTPAT are the only sensors that **can be connected directly to a PC** with OPTIBRIDGE (USB interface cable) and **calibrated** in accordance with **HART® protocol**. Offline calibration can be carried out in a favourable environment instead of at the point of measurement under possibly onerous plant conditions.

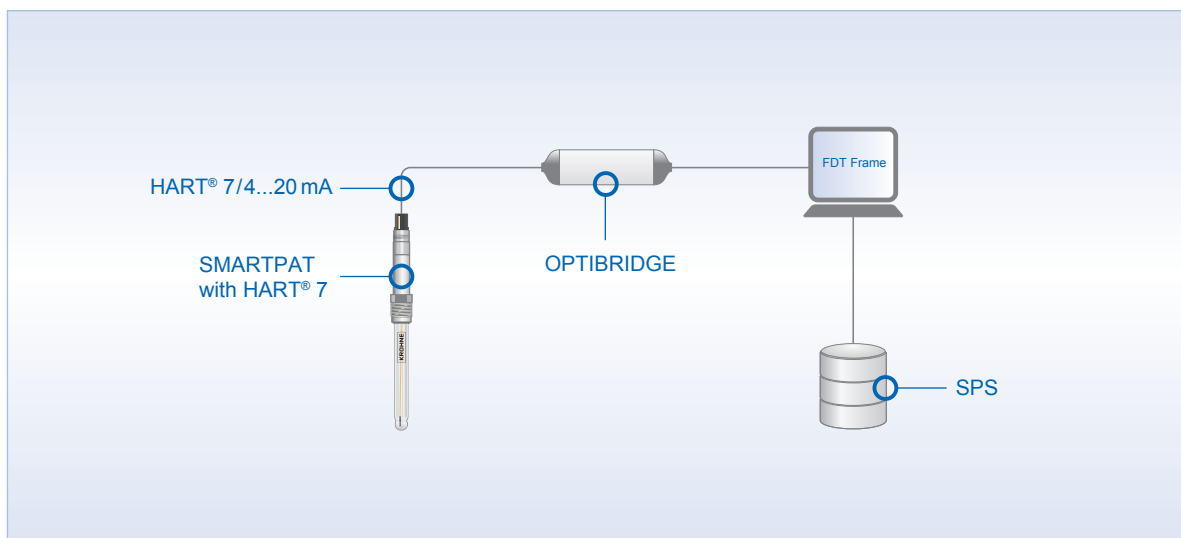

Effect 1: Extended service life

Offline calibration takes place in a controlled environment. **The sensors are cleaned and regenerated at the same time.** Depending on the application purpose and site, their service life is longer under these circumstances.

Effect 2: More precise results





Much more exact calibration can be performed under controlled conditions. This enables more precise measuring results and higher product quality.

Effect 3: Faster replacement

SMARTPAT sensors store the calibration data and on installation at the measurement point no further calibration is required. This **reduces installation time** to just a few minutes per measuring loop.

SMARTPAT portfolio

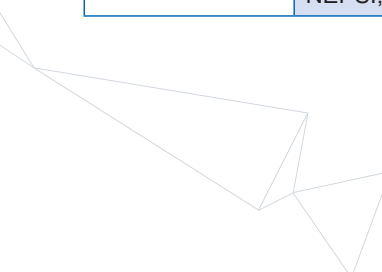

pH sensors

	High performance pH sensor for chemical industry	Hygienic pH sensor for food, beverage and pharmaceutical industry	pH sensor for pure water applications	Durable, universal pH-sensor for water and wastewater applications	Rugged pH sensor with 3/4" NPT process connection for water applications
Sensor type	SMARTPAT PH 8150	SMARTPAT PH 8570	SMARTPAT PH 8530	SMARTPAT PH 8320	SMARTPAT PH 1590
					
Diaphragm	Open	Ceramic	Ceramic	PTFE	Ceramic
Reference	Duralid gel	RheoLid gel	KCl gel	Ag / AgCl / TepoxGel	KCl gel
Sensing element	H glass	S glass	A glass	AH glass	Multi purpose glass
Temperature range	0...+130°C / +32...+266°F	0...+140°C / +32...+284°F (CIP, SIP, autoclavable)	0...+80°C / +32...+176°F	0...+70°C / +32...+158°F	0...+80°C / +32...+176°F
Pressure range	Max. 12 bar / 174 psi	Max. 12 bar / 174 psi	Max. 12 bar / 174 psi	Max. 10 bar / 145 psi	Max. 6,9 bar / 100 psi
Communication	1 × 4...20 mA (passive), HART®	1 × 4...20 mA (passive), HART®	1 × 4...20 mA (passive), HART®	1 × 4...20 mA (passive), HART®	1 × 4...20 mA (passive), HART®
Power supply	15...30 V (loop powered)	15...30 V (loop powered)	15...30 V (loop powered)	15...30 V (loop powered)	15...30 V (loop powered)
Temperature sensor	Pt1000	Pt1000	Pt1000	Pt1000	Pt1000
Connector	VP (VarioPin)	VP (VarioPin)	VP (VarioPin)	VP (VarioPin)	VP (VarioPin)
Approvals	IECEX, ATEX, NEPSI, FM (zone 0)	IECEX, ATEX, NEPSI, FM (zone 0)	–	IECEX, ATEX, NEPSI, FM (zone 0)	–



pH sensors

ORP sensors

	Rugged pH sensor with 3/4" NPT process connection for wastewater applications	High performance ORP sensor for harsh applications	General purpose ORP sensor for water applications	Rugged ORP sensor with 3/4" NPT process connection for water and wastewater applications
Sensor type	SMARTPAT PH 2390	SMARTPAT ORP 8150	SMARTPAT ORP 8510	SMARTPAT ORP 1590
				
Diaphragm	PTFE	Open	Ceramic	Ceramic
Reference	KCl gel	Duralid gel	Ag/AgCl/TepoxGel	KCl gel
Sensing element	Multi purpose glass	Platinum	Platinum	Platinum
Temperature range	0...+80°C / +32...+176°F	0...+130°C / +32...+266°F	0...+70°C / +32...+158°F	0...+80°C / +32...+176°F
Pressure range	Max. 6,9 bar / 100 psi	Max. 12 bar / 174 psi	Max. 2 bar / 30 psi	Max. 6,9 bar / 100 psi
Communication	1 × 4...20 mA (passive), HART® 7	1 × 4...20 mA (passive), HART® 7	1 × 4...20 mA (passive), HART® 7	1 × 4...20 mA (passive), HART® 7
Power supply	15...30V (loop powered)	15...30V (loop powered)	15...30V (loop powered)	15...30V (loop powered)
Temperature sensor	Pt1000	Pt1000	Pt1000	Pt1000
Connector	VP (VarioPin)	VP (VarioPin)	VP (VarioPin)	VP (VarioPin)
Approvals	-	IECEX, ATEX, NEPSI, FM (zone 0)	-	-

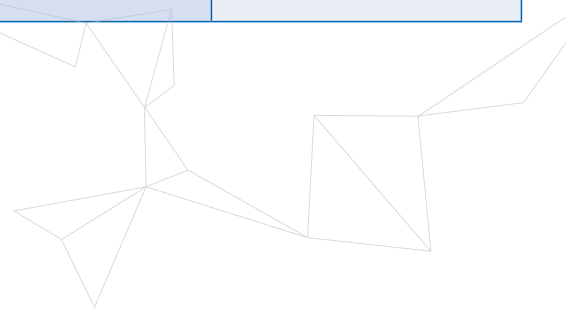

Алматы (7273)495-231
Ангарск (3955)60-70-56
Архангельск (8182)63-90-72
Астрахань (8512)99-46-04
Барнаул (3852)73-04-60
Белгород (4722)40-23-64
Благовещенск (4162)22-76-07
Брянск (4832)59-03-52
Владивосток (423)249-28-31
Владикавказ (8672)28-90-48
Владимир (4922)49-43-18
Волгоград (844)278-03-48
Вологда (8172)26-41-59
Воронеж (473)204-51-73
Екатеринбург (343)384-55-89
Иваново (4932)77-34-06
Ижевск (3412)26-03-58
Иркутск (395)279-98-46
Казань (843)206-01-48

Калининград (4012)72-03-81
Калуга (4842)92-23-67
Кемерово (3842)65-04-62
Киров (8332)68-02-04
Коломна (4966)23-41-49
Кострома (4942)77-07-48
Краснодар (861)203-40-90
Красноярск (391)204-63-61
Курган (3522)50-90-47
Курск (4712)77-13-04
Липецк (4742)52-20-81
Магнитогорск (3519)55-03-13
Москва (495)268-04-70
Мурманск (8152)59-64-93
Набережные Челны (8552)20-53-41
Нижний Новгород (831)429-08-12
Новокузнецк (3843)20-46-81
Новосибирск (383)227-86-73
Ноябрьск(3496)41-32-12

Омск (3812)21-46-40
Орел (4862)44-53-42
Оренбург (3532)37-68-04
Пенза (8412)22-31-16
Пермь (342)205-81-47
Петрозаводск (8142)55-98-37
Псков (8112)59-10-37
Ростов-на-Дону (863)308-18-15
Рязань (4912)46-61-64
Самара (846)206-03-16
Санкт-Петербург (812)309-46-40
Саранск (8342)22-96-24
Саратов (845)249-38-78
Севастополь (8692)22-31-93
Симферополь (3652)67-13-56
Смоленск (4812)29-41-54
Сочи (862)225-72-31
Ставрополь (8652)20-65-13
Сургут (3462)77-98-35

Сыктывкар (8212)25-95-17
Тамбов (4752)50-40-97
Тверь (4822)63-31-35
Тольятти (8482)63-91-07
Томск (3822)98-41-53
Тула (4872)33-79-87
Тюмень (3452)66-21-18
Улан-Удэ (3012)59-97-51
Ульяновск (8422)24-23-59
Уфа (347)229-48-12
Хабаровск (4212)92-98-04
Чебоксары (8352)28-53-07
Челябинск (351)202-03-61
Череповец (8202)49-02-64
Чита (3022)38-34-83
Якутск (4112)23-90-97
Ярославль (4852)69-52-93

Россия +7(495)268-04-70

Казахстан +7(7172)727-132

Киргизия +996(312)96-26-47

<https://opti.nt-rt.ru> || opti@nt-rt.ru